

AXOR Citterio E

Rough, Thermostatic Module 15" x 5" for 3 Functions, without Service Stops

Finish: Part no. : **36708181**



Description

Features

- 3 outlets (no shared function)
- Connection thread: 3/4" NPT
- Horizontal or vertical installation
- Quick connection for easy, leak-free installation

Item details

List Price \$ 1,595.00

Compliance / Sustainability

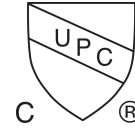

Product image



Scale drawing

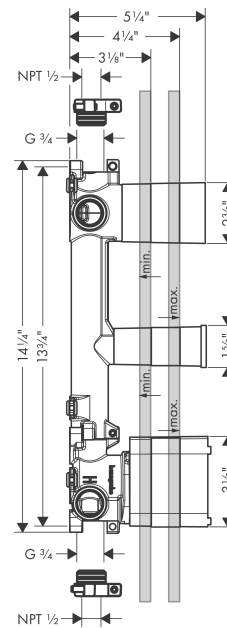

AXOR Citterio E

Rough, Thermostatic Module 15" x 5" for 3 Functions, without Service Stops

Finish: Part no. : **36708181**



Exploded drawing

Year of production: >01/16

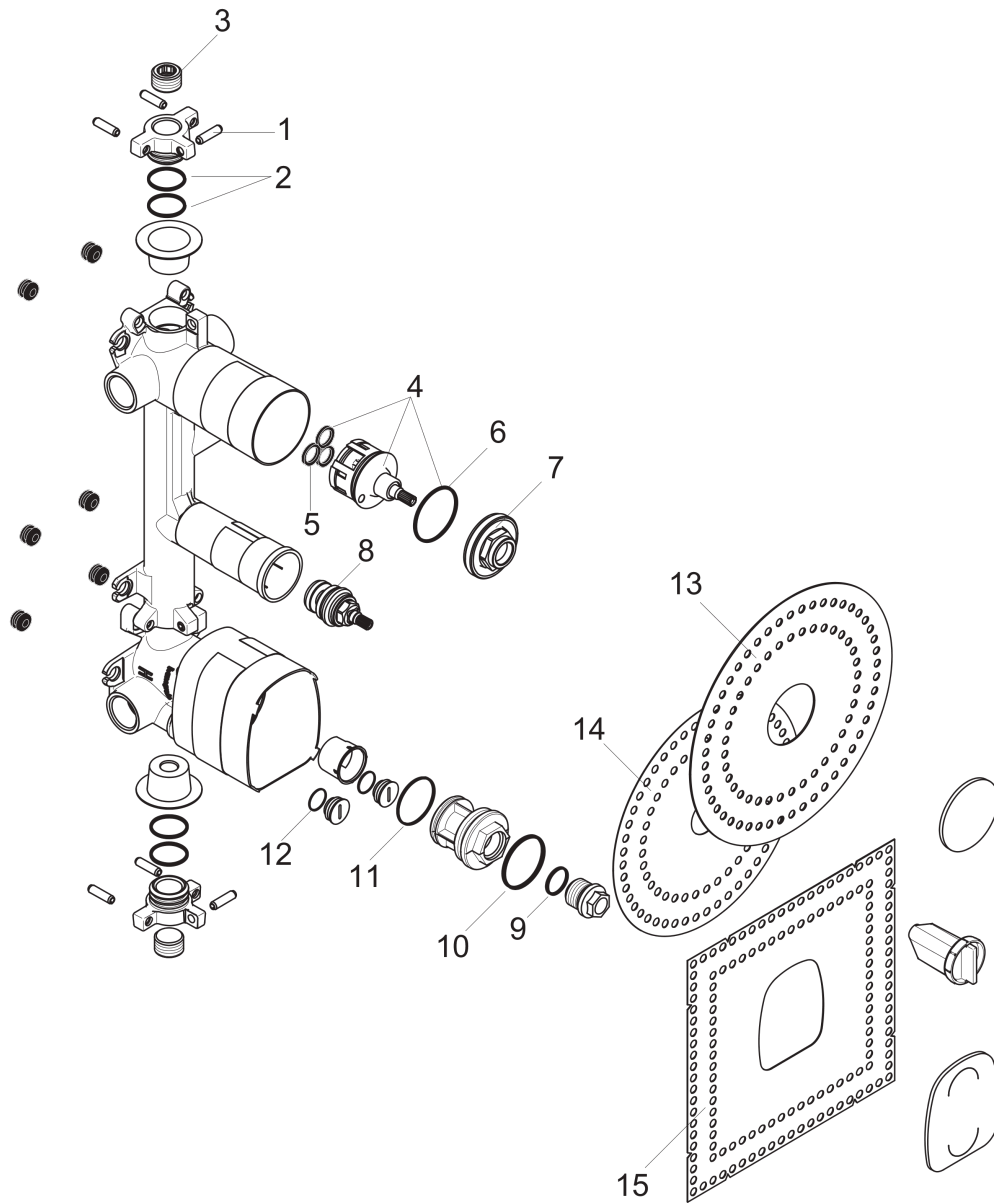

AXOR Citterio E

Rough, Thermostatic Module 15" x 5" for 3 Functions, without Service Stops

Finish: Part no. : **36708181**



Spare parts list

Year of production: >01/16

Pos.	Description	Part no.	Price	PU
1	pin	95334000	-	1
2	O-Ring 23x2,5	98183000	-	1
3	plug	97998001	-	1
4	diverter unit	96604001	-	1
5	sealing set	98798000	-	1
6	O-ring 39x2,5	92322000	-	1
7	screw M5 x 24	97555000	-	1
8	shut off unit with spindle DN20 (3/4")	92929000	-	1
9	O-ring 18x2	98181000	-	1
10	O-ring 38x2,5	98198000	-	1
11	O-ring 34x2	98383000	-	1
12	O-ring 15x1,5	92118000	-	1
13	sealing foil	96493000	-	1
14	sealing foil	96492000	-	1
15	sealing foil	95389000	-	1
a	plug	92859000	-	1