



Electronic Lavatory Faucets

Less Power - Deck Mount Electronic Lavatory Faucet -
8" (203mm) centers

Model No: 592-PALGHDF-LP

COMPLIES WITH:

- CSA certified
- Complies to ASME A112.18.1/CSA B125.1
-  Indicates compliance to ICC/ANSI A117.1
- Verified compliant with 0.25% weighted average Pb content regulations
- Patented
- **NOTE 1:** Designed for routine 180°F (82°C) disinfection cycles up to 10 minutes.
- **NOTE 2:** Use only Delta® supplied cable sets. Using non-Delta® cables, cutting or splitting any components will void the warranty.
- **NOTE 3:** Proximity® models not for use on enamel covered metal sinks or metal counter tops.
- **NOTE 4:** Less Power (LP) models must be used with Plug-in (PI) model **ONLY**.
- (Contact Delta Representative for State and/or Local Approvals)



NOTES:

Control(0) - Supplied as COMPLETE PRODUCT ONLY

FOR SEPARATE TEMPERING VALVE, SEE TEMPERING

SPECIFICATION:

- Proximity® Sensing Technology
- Adjustable sensing range and timeout
- All metal spout construction
- Deck mount electronic lavatory faucet
- Serviceable filter screen upstream of the solenoid valve
- Vandal resistant 0.5 gpm (1.9 L/min) laminar outlet
- 8" (203mm) coverplate with anti-rotation pin
- Mixing valve required (order separately)
- Solenoid and Controller in Surface Mount Housing - REQUIRED SINGLE TEMPERED WATER SUPPLY
- Maximum combination of 5 faucets and 4 ganging cables can be connected to 1 plug-in power supply.

OPERATION:

- Hands free (touchless) operation.
- No visible sensor, the spout is the sensor.
- Water flows when sensing is activated.
- Water flow stops upon de-activation of sensing.
- Adjustable sensing distance factory set to 3" (76 mm).
- Adjustable auto shut off feature. Factory set to 45 seconds.
- Metering mode with selectable flow times of 7 seconds to 4 minutes, factory set off.
- Periodic Rinse feature, time adjustable in 6 hour increments up to 2 days. Selectable rinsing time from 10 to 180 seconds. Factory set off.

(Dimensional drawing on following page)

Delta reserves the right (1) to make changes to specifications and materials, and (2) to change or discontinue models, both without notice or obligation. Dimensions are for reference. Measurement may vary plus or minus 6mm(0.25"). Mounting locations are suggested only. Check with local codes for requirements in your area. This spec was produced May 08, 2021.

Delta Faucet Company - 55 East 111th St. - Indianapolis, Indiana, USA 46280 - (317) 848-1812
Delta Faucet Canada - 395 Matheson Blvd E - Mississauga, Ontario, Canada L4Z 2H2 - (905) 712-3030

Model No: 592-PALGHDF-LP

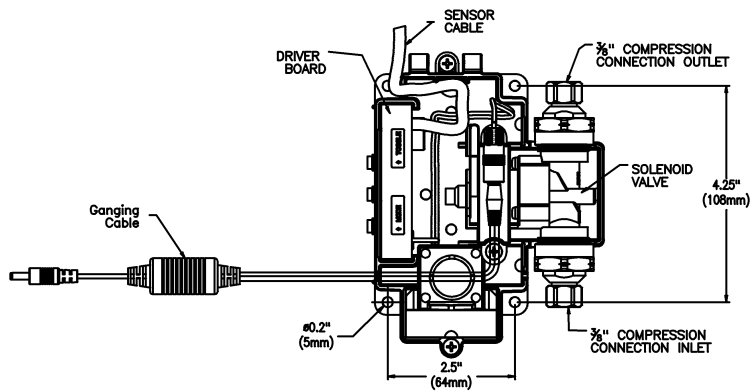
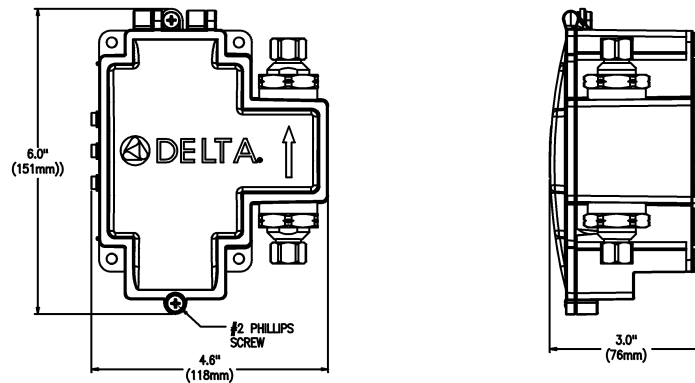
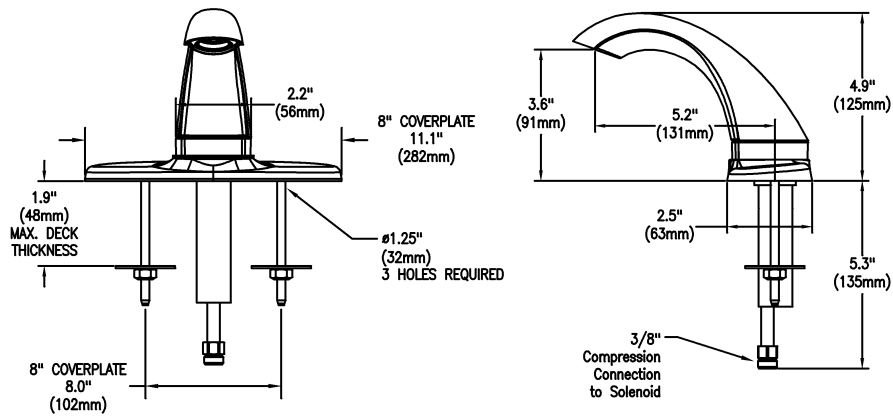

- NOTE:
1. BRAIDED POLYMER HOSE (SUPPLIED) TO BE USED BETWEEN SOLENOID OUTLET AND SPOUT.
 2. 2nd BRAIDED POLYMER HOSE (SUPPLIED) TO BE USED BETWEEN SOLENOID INLET AND WATER SUPPLY.
 3. 13" MAX. DISTANCE BETWEEN DECK AND SURFACE MOUNT BOX.

Delta reserves the right (1) to make changes to specifications and materials, and (2) to change or discontinue models, both without notice or obligation. Dimensions are for reference. Measurement may vary plus or minus 6mm(0.25"). Mounting locations are suggested only. Check with local codes for requirements in your area. This spec was produced May 08, 2021.

Delta Faucet Company - 55 East 111th St. - Indianapolis, Indiana, USA 46280 - (317) 848-1812
 Delta Faucet Canada - 395 Matheson Blvd E - Mississauga, Ontario, Canada L4Z 2H2 - (905) 712-3030