

### Features

- Single-function rainhead
- MasterClean™ sprayface features an easy-to-clean surface that withstands mineral buildup and maximizes spray performance
- Optimized sprayface for maximum performance
- 2.5 gpm (9.5 lpm) maximum flow rate

### Material

- Solid-brass construction for durability and reliability

### Technology

- Katalyst® air-induction technology infuses water with air, creating bigger drops for a more powerful spray

### Installation

- 1/2" -14 NPT connection



### Codes/Standards









ASME A112.18.1/CSA B125.1  
DOE - Energy Policy Act 1992  
NOM Standards  
NOM 008-CONAGUA

### KOHLER® Faucet Lifetime Limited Warranty

See website for detailed warranty information.

### Available Colors/Finishes

*Color tiles intended for reference only.*

Color	Code	Description
	CP	Polished Chrome
	SN	Vibrant® Polished Nickel
	BN	Vibrant® Brushed Nickel
	BV	Vibrant® Brushed Bronze
	BL	Matte Black
	2MB	Vibrant® Brushed Moderne Brass
	TT	Vibrant Titanium
	BGP	Vibrant Brushed Graphite
	DR	Deep Bronze

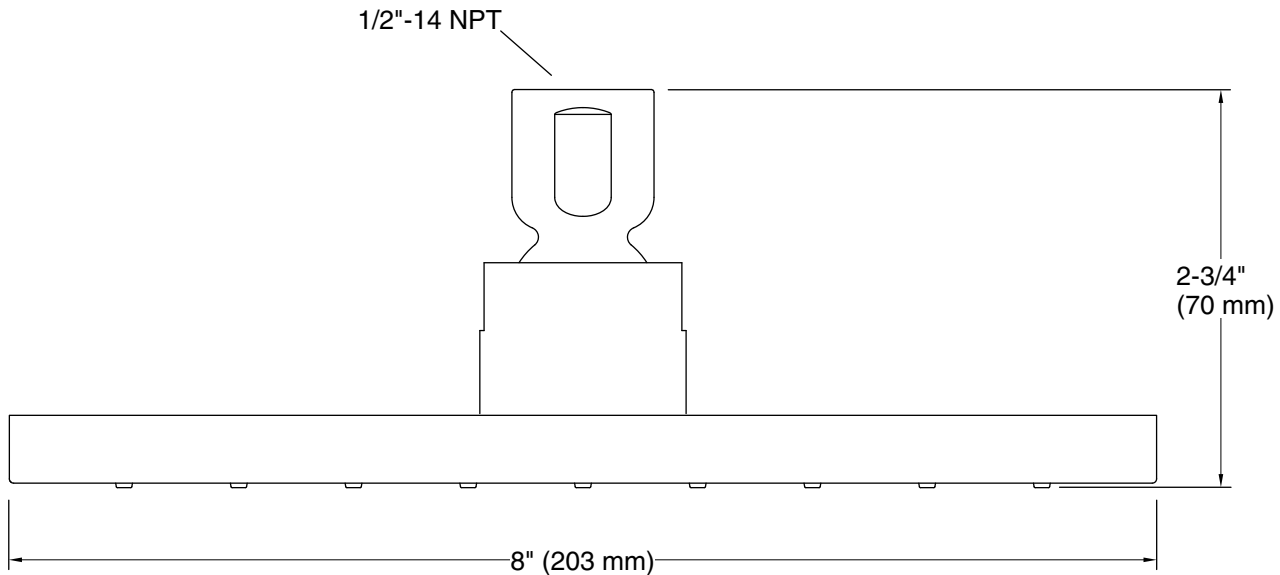

**Technical Information**

All product dimensions are nominal.

**Spout:**

Shower/Rainhead rated max flow: 2.5 gal/min (9.5 l/min)

**Notes**

Install this product according to the installation instructions.