

Features

- Left-hand trip lever
- For use with the K-20197 and K-20198 Betello™ toilets

Material

- Premium metal construction for durability and reliability
- KOHLER finishes resist corrosion and tarnishing



ADA

CSA B651

OBC

Codes/Standards











ADA
ICC/ANSI A117.1
CSA B651
OBC

KOHLER® One-Year Limited Warranty

See website for detailed warranty information.

Available Colors/Finishes

Color tiles intended for reference only.

Color	Code	Description
	CP	Polished Chrome
	SN	Vibrant® Polished Nickel
	AF	Vibrant® French Gold
	BN	Vibrant® Brushed Nickel
	BV	Vibrant® Brushed Bronze
	BL	Matte Black
	2MB	Vibrant® Brushed Moderne Brass
	BGP	Vibrant Brushed Graphite
	TT	Vibrant Titanium
	DR	Deep Bronze

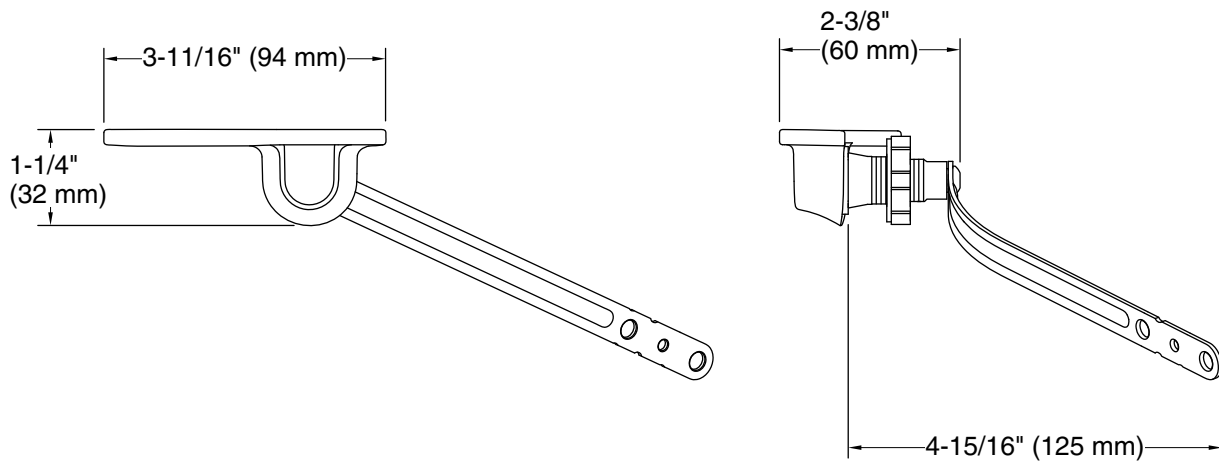

Technical Information

All product dimensions are nominal.

Material: Metal

Notes

ADA, OBC, CSA B651 compliant when installed to the specific requirements of these regulations.