

### Features

- High-arch rotating spout offers superior clearance for filling pots and cleaning
- Two round handles offer separate control of hot and cold water
- KOHLER® ceramic disc valves exceed industry longevity standards for a lifetime of durable performance
- 1.5 gpm (5.7 lpm) maximum flow rate at 60 psi (4.14 bar)
- Coordinates with other products in the Billet™ collection

### Material

- Premium metal construction for durability and reliability
- KOHLER finishes resist corrosion and tarnishing

### Installation

- Wall-mount



### Codes/Standards









ASME A112.18.1/CSA B125.1  
NSF/ANSI/CAN 61  
NSF/ANSI/CAN 372  
DOE - Energy Policy Act 1992  
California Energy Commission (CEC)

### KOHLER® Faucet Lifetime Limited Warranty

See website for detailed warranty information.

### Available Colors/Finishes

*Color tiles intended for reference only.*

Color	Code	Description
	CP	Polished Chrome
	SN	Vibrant® Polished Nickel
	AF	Vibrant® French Gold
	VS	Vibrant® Stainless
	BV	Vibrant® Brushed Bronze
	BL	Matte Black
	2MB	Vibrant® Brushed Moderne Brass
	BMB	Matte Black with Moderne Brass
	TT	Vibrant Titanium

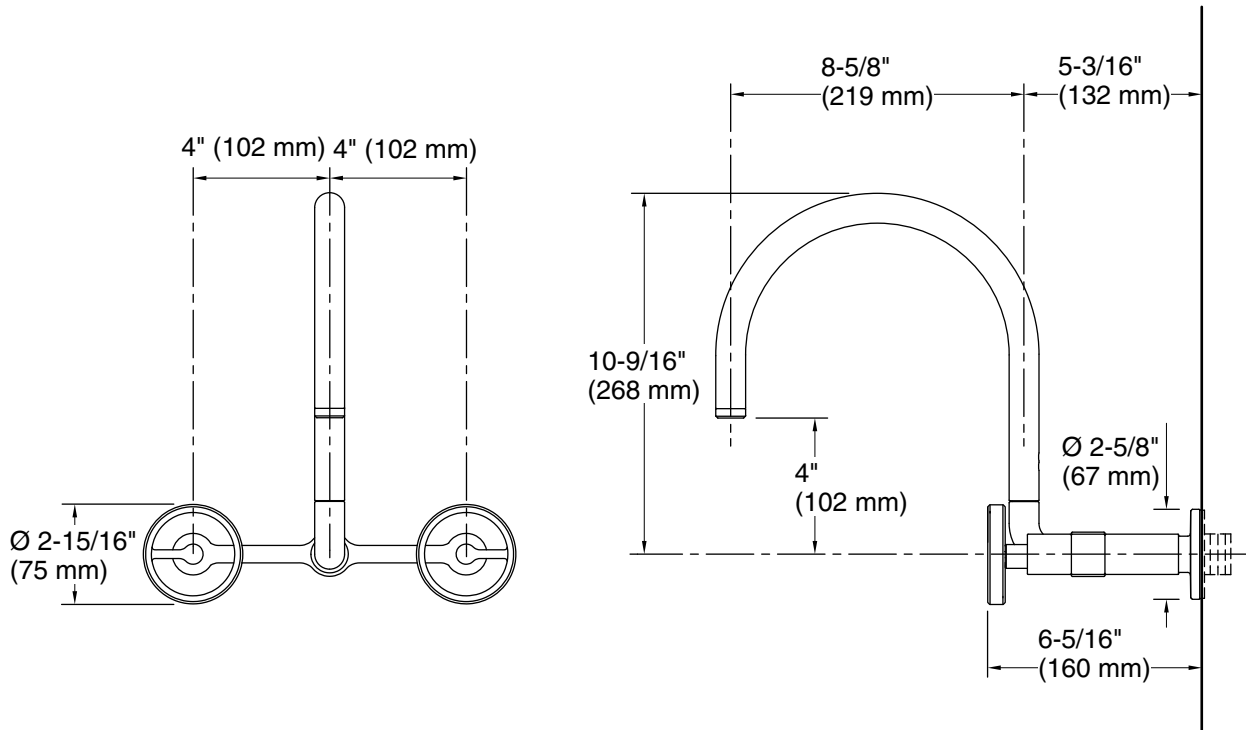

**Technical Information**

All product dimensions are nominal.

Faucet flow rate: 1.5 gal/min (5.7 l/min)

**Spout:**

Spout reach: 8-5/8" (218 mm)

**Notes**

Install this product according to the installation instructions.