

Features

- Frameless design emphasizes glass and creates a sleek, minimalist look
- Vertical handle with inside knob on moving panel
- Tempered glass ensures enhanced safety and durability
- CleanCoat®+ glass coating creates a hydrophobic barrier that repels water, soap scum, and residue, saving time and protecting shower doors 10 times longer than original CleanCoat. (Based on 2021 internal wear/abrasion testing using a microfiber cloth.)
- Smooth, easy-to-clean wall jambs
- Full-length moving panel seal provides excellent water containment
- Controlled Close® innovative soft-close with double-dampening technology brings door to a secure close
- Shower door configuration consists of one sliding panel and one stationary panel
- Coordinates with other products in the Rely collection

Material

- Frameless, 3/8" (10 mm) thick Crystal Clear tempered glass with easy-to-clean rectangular grille design imprinted on surface
- Anodized aluminum prevents rust and corrosion

Installation

- Fits opening widths 56-5/8" – 59-5/8" (1438 –1514 mm)
- 77" (1956 mm) high, with a lofty 73-7/8" (1876 mm) minimum head clearance
- 3" (76 mm) width adjustment
- Out-of-plumb adjustability simplifies installation
- Door can be installed to open to the left or right to suit your bathroom layout
- For residential use only
- Not for use in hospitality



Codes/Standards

ANSI Z97.1
CAN/CGSB-12.1
CPSC 16CFR 1201

KOHLER® Bath and Shower Doors Ten-Year Limited Warranty

See website for detailed warranty information.

Available Colors/Finishes

Color tiles intended for reference only.

Color	Code	Description
	BL	Matte Black

Available Glass Options

Code	Description
G79	Crystal Clear with Rectangular Grille Pattern

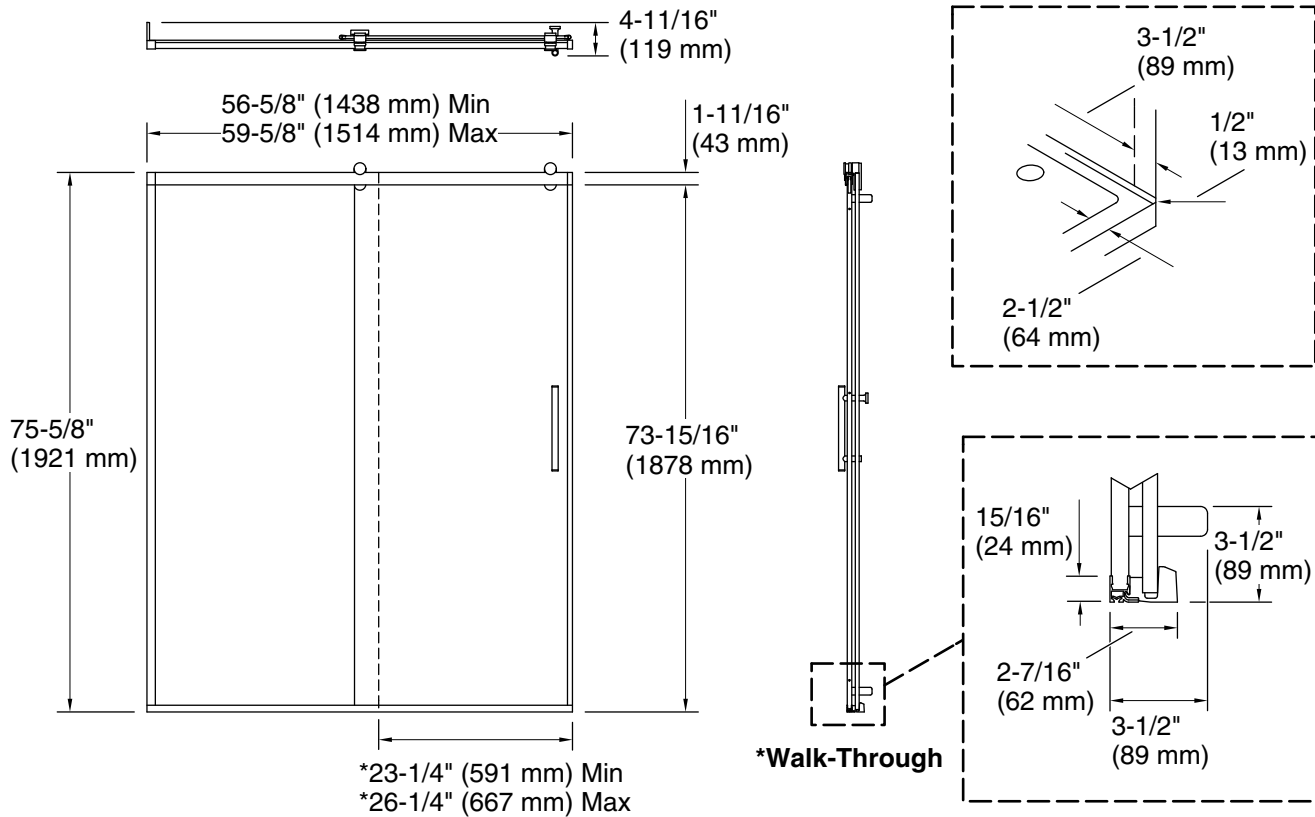

Technical Information

All product dimensions are nominal.

Base-To-Wall	1/2" (13 mm)
Radius – Max:	
Shower Ledge Min	2-1/2" (64 mm)
Flat:	
Shower Wall Min	3-1/2" (89 mm)
Flat:	

Notes

Install this product according to the installation instructions.

The vertical opening should be a minimum of 78-1/2" (1994 mm) to allow for installation clearance.