

Features

- Frameless design emphasizes glass and creates a sleek, minimalist look
- Vertical handle with inside knob on moving panel
- Gently-curved towel bar provides integrated storage on fixed panel
- Tempered glass ensures enhanced safety and durability
- CleanCoat®+ glass coating creates a hydrophobic barrier that repels water, soap scum, and residue, saving time and protecting shower doors 10 times longer than original CleanCoat. (Based on 2021 internal wear/abrasion testing using a microfiber cloth.)
- Smooth, easy-to-clean wall jambs
- Full-length moving panel seal provides excellent water containment
- Coordinates with other products in the Elate collection
- Shower door configuration consists of one sliding panel and one stationary panel

Material

- Frameless, heavy 5/16" (8 mm) thick Frosted tempered glass with easy-to-clean rectangular grille design imprinted on surface
- Anodized aluminum prevents rust and corrosion

Installation

- Fits opening widths 62-1/4" - 65-5/8" (1581 - 1667 mm)
- 75-1/2" (1918 mm) tall, with a lofty 72-11/16" (1846 mm) minimum head clearance
- 3-3/8" (86 mm) width adjustment
- Out-of-plumb adjustability simplifies installation
- Door can be installed to open to the left or right to suit your bathroom layout
- For residential use only
- Not for use in hospitality



Codes/Standards

ANSI Z97.1
CAN/CGSB-12.1
CPSC 16CFR 1201

KOHLER® Bath and Shower Doors Ten-Year Limited Warranty

See website for detailed warranty information.

Available Colors/Finishes

Color tiles intended for reference only.

Color	Code	Description
■	BL	Matte Black

Available Glass Options

Code	Description
G80	Frosted with Rectangular Grille Pattern

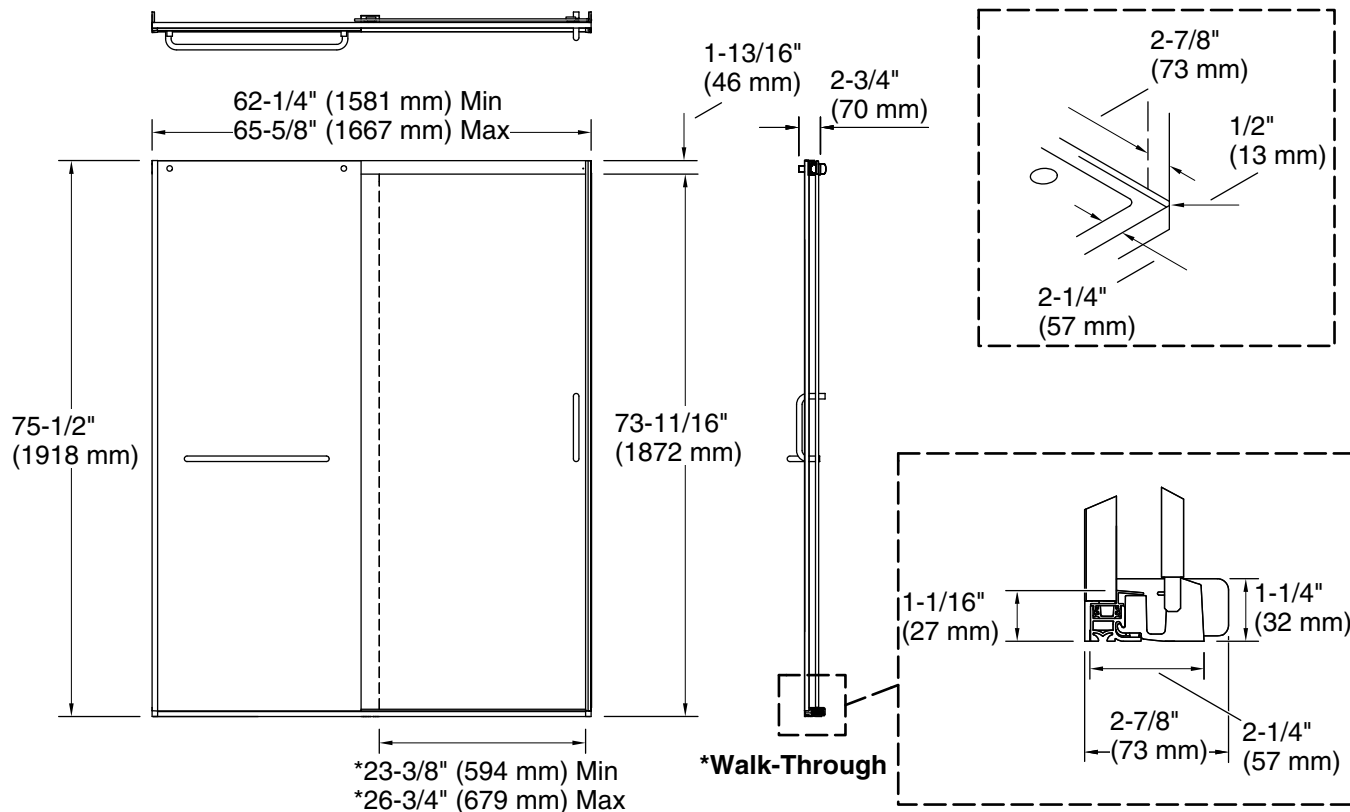

Technical Information

All product dimensions are nominal.

Base-To-Wall	1/2" (13 mm)
Radius – Max:	
Shower Ledge Min	2-1/4" (57 mm)
Flat:	
Shower Wall Min	2-7/8" (73 mm)
Flat:	

Notes

Install this product according to the installation instructions.

The vertical opening should be a minimum of 78-13/16" (2002 mm) to allow for installation clearance.