



# Iron Works®

## 1-1/2" Exposed Bath Drain

### K-7104

#### Features

- 17-gauge brass construction
- Brass tailpiece
- Adjustable trip lever
- For above-the-floor installations
- For use with Iron Works Historic™ freestanding baths

#### Recommended Products/Accessories

K-23726 Drain treatment



#### Codes/Standards







ASME A112.18.2/CSA B125.2

#### KOHLER® One-Year Limited Warranty

See website for detailed warranty information.

#### Available Colors/Finishes

*Color tiles intended for reference only.*

| Color   | Code | Description                    |
|---|------|--------------------------------|
|  | CP   | Polished Chrome                |
|  | SN   | Vibrant® Polished Nickel       |
|  | AF   | Vibrant® French Gold           |
|  | BN   | Vibrant® Brushed Nickel        |
|  | BV   | Vibrant® Brushed Bronze        |
|  | 2MB  | Vibrant® Brushed Moderne Brass |

1-800-4KOHLER (1-800-456-4537)

Kohler Co. reserves the right to make revisions without notice to product specifications.

For the most current Specification Sheet, go to [www.kohler.com](http://www.kohler.com) USA or [www.kohler.ca](http://www.kohler.ca) Canada

9-19-2025 18:18 - US/CA

THE BOLD LOOK  
OF **KOHLER**®

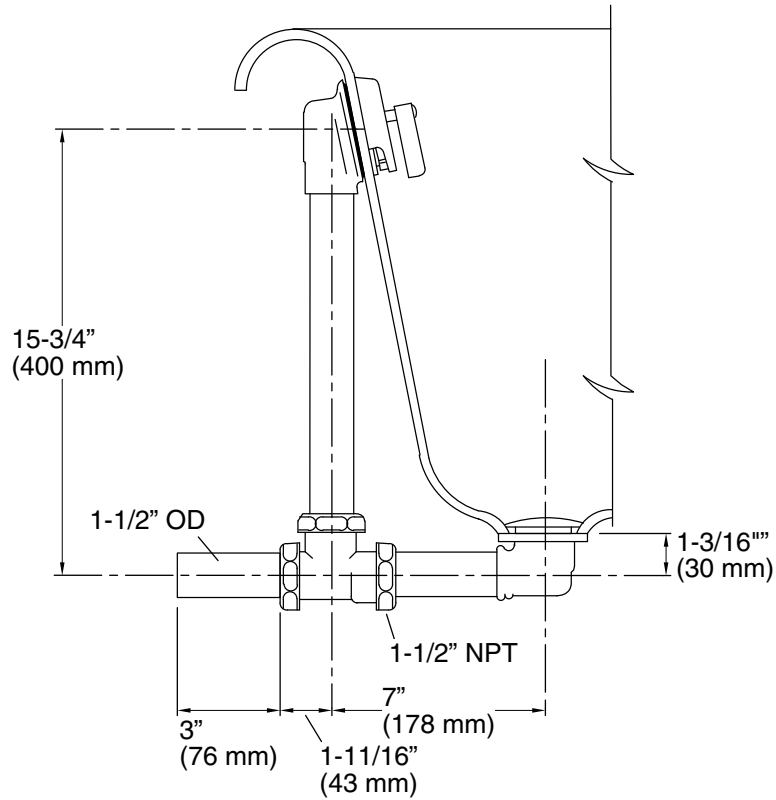

### Technical Information

All product dimensions are nominal.

Material: Brass

### Notes

Install this product according to the installation instructions.