

KOHLER® Faucets

Two-hole bridge kitchen sink faucet with side sprayer
Purist®
K-7548-4

Features

- Matching side sprayer provides flexibility and convenience for cleaning and food prep
- KOHLER® ceramic disc valves exceed industry longevity standards for a lifetime of durable performance
- Two Lever handles offer separate control of hot and cold water
- Coordinates with other products in the Purist collection
- 1.5 gpm (5.7 lpm) maximum flow rate at 60 psi (4.14 bar)

Material

- Premium metal construction for durability and reliability
- KOHLER finishes resist corrosion and tarnishing

Installation

- Three-hole installation
- Flexible supply lines simplify installation

Recommended Products/Accessories

- K-77685 Single-cartridge water filtration system
- K-77686 Double-cartridge water filtration system
- K-77687 single replacement filter cartridge
- K-77688 Replacement Filter Cartridges, Two-Pack



ADA **CSA B651**

Codes/Standards







ASME A112.18.1/CSA B125.1
 NSF/ANSI/CAN 61
 NSF/ANSI/CAN 372
 DOE - Energy Policy Act 1992
 California Energy Commission (CEC)
 ADA
 ICC/ANSI A117.1
 CSA B651

KOHLER® Faucet Lifetime Limited Warranty

See website for detailed warranty information.

Available Colors/Finishes

Color tiles intended for reference only.

Color	Code	Description
	CP	Polished Chrome
	SN	Vibrant® Polished Nickel
	VS	Vibrant® Stainless
	BL	Matte Black
	2MB	Vibrant® Brushed Moderne Brass
	BGP	Vibrant Brushed Graphite
	TT	Vibrant Titanium

1-800-4KOHLER (1-800-456-4537)

Kohler Co. reserves the right to make revisions without notice to product specifications.

For the most current Specification Sheet, go to www.kohler.com USA or www.kohler.ca Canada

10-18-2025 20:45 - US/CA

THE BOLD LOOK
 OF **KOHLER®**

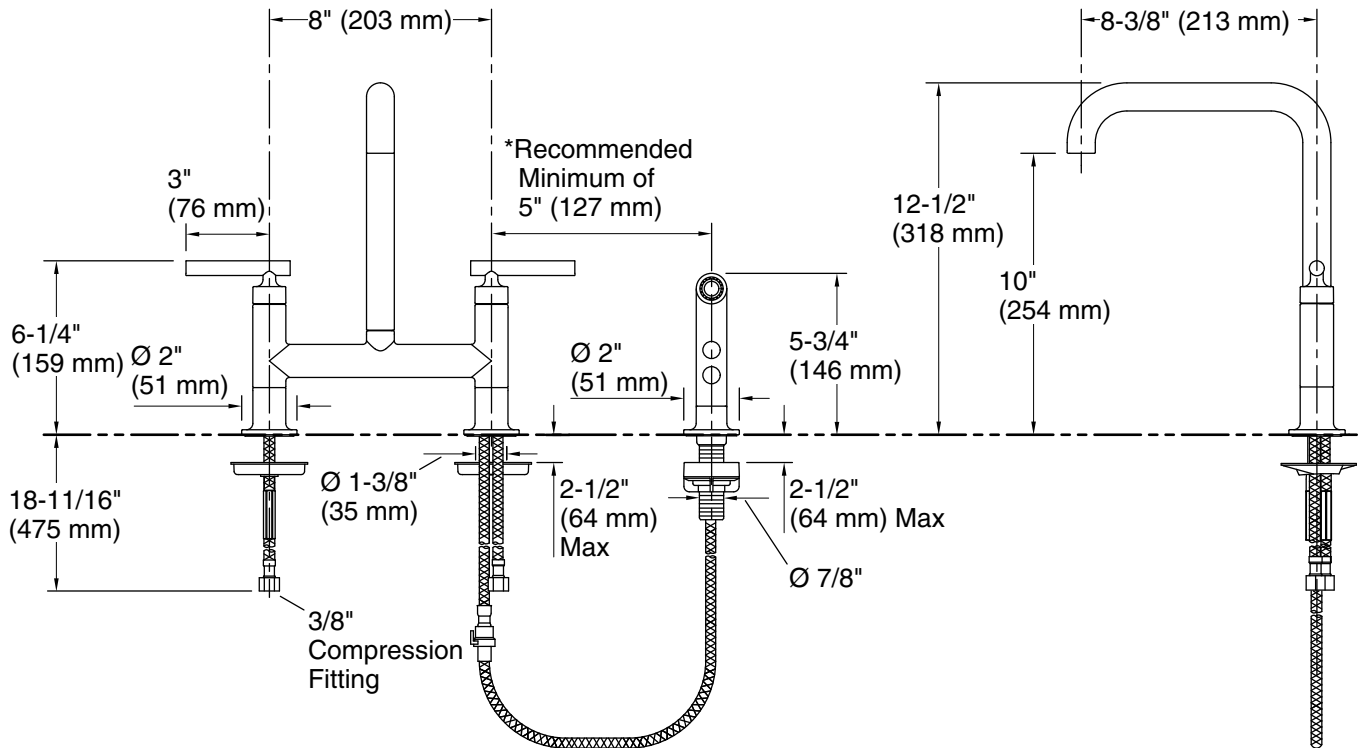

Technical Information

All product dimensions are nominal.

Faucet flow rate: 1.5 gal/min (5.7 l/min)

Spout:

Spout reach: 8-3/8" (213 mm)

Notes

Install this product according to the installation guide.

Drill the hole for the sidespray a minimum of 5" (127 mm) from the center of the lever handle.

ADA compliant for faucet handles only

ADA, CSA B651 compliant when installed to the specific requirements of these regulations.