

Features

- 2.0 gpm (7.6 lpm) maximum flow rate at 80 psi (5.5 bar)
- Single-function 54-nozzle body spray delivers a soothing spray
- Fully adjustable sprayface pivots for targeted hydromassage
- Low-profile design complements any decor
- MasterClean™ sprayface features an easy-to-clean surface that withstands mineral buildup and maximizes spray performance
- 1/2" NPT connections
- Available 27- or 54-nozzle configurations

Material

- KOHLER finishes resist corrosion and tarnishing

Installation

- Ceiling- or wall-mount



Codes/Standards









ASME A112.18.1/CSA B125.1
DOE - Energy Policy Act 1992
NOM Standards
NOM 008-CONAGUA

KOHLER® Faucet Lifetime Limited Warranty

See website for detailed warranty information.

Available Colors/Finishes

Color tiles intended for reference only.

Color	Code	Description
	CP	Polished Chrome
	SN	Vibrant® Polished Nickel
	AF	Vibrant® French Gold
	BN	Vibrant® Brushed Nickel
	BV	Vibrant® Brushed Bronze
	BL	Matte Black
	2MB	Vibrant® Brushed Moderne Brass
	TT	Vibrant Titanium
	BGP	Vibrant Brushed Graphite

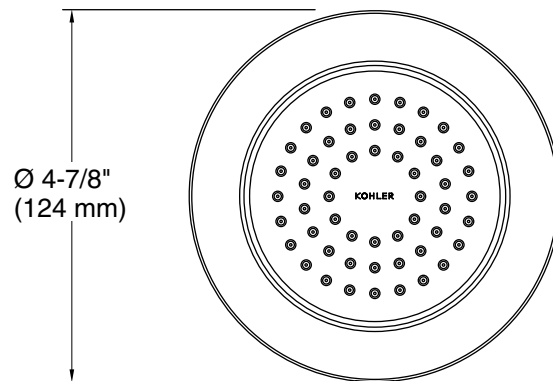
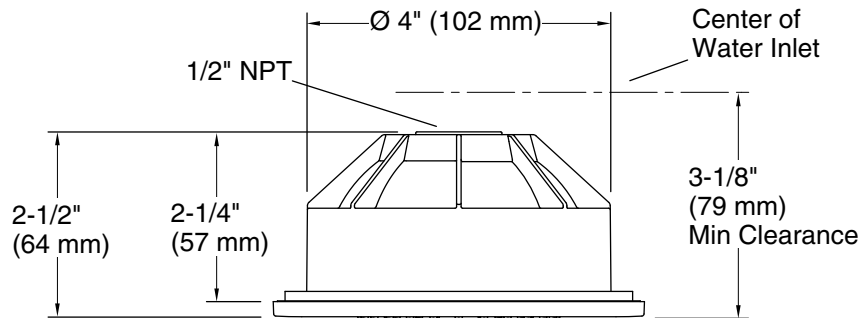

Technical Information

All product dimensions are nominal.

Spout:

Notes

Install this product according to the installation instructions.