

Features

- Lavatory system with backsplash offers contemporary styling for commercial applications
- Basin and trough slope design prevents water from splashing back on user
- Back ledge provides a dry space for storing cell phones and other devices
- Faucets and soap dispensers attach to lavatory backsplash, eliminating the need to drill through finished wall
- Predrilled mounting holes for faucets and soap dispensers
- Drain strainers help prevent debris from entering drains
- Lavatory system available in your choice of Silestone® quartz or Corian® Solid Surface in a host of color options
- Silestone® quartz provides exceptional durability and stain resistance, making it easy to maintain
- Corian® Solid Surface has a nonporous surface to help prevent bacteria and mold growth
- Vandal-resistant locking doors on stainless steel shroud conceal pipes and swing open to provide easy below-deck access for maintenance
- Requires select Composed® wall-mount faucet and soap dispenser bundles (sold separately)

Installation

- Wall-mount

Recommended Products/Accessories

K-181025-BC1 Touchless lavatory faucets and soap dispensers for Constellation™ lavatory system, 0.5 gpm



ADA

CSA B651

Codes/Standards











IAPMO IGC 156
ADA
ICC/ANSI A117.1
CSA B651

KOHLER® One-Year Limited Warranty

See website for detailed warranty information.

Available Colors/Finishes

Color tiles intended for reference only.

Color	Code	Description
	KCC	Canvas
	KCD	Designer White
	KCE	Ash Concrete
	KCG	Glacier White
	KCN	Neutral Concrete
	KCR	Arrow Root
	KCT	Concrete
	KEB	Et Bianco Cal
	KED	Desert Silver
	KEG	Et Cal Gold
	KEH	Miami White

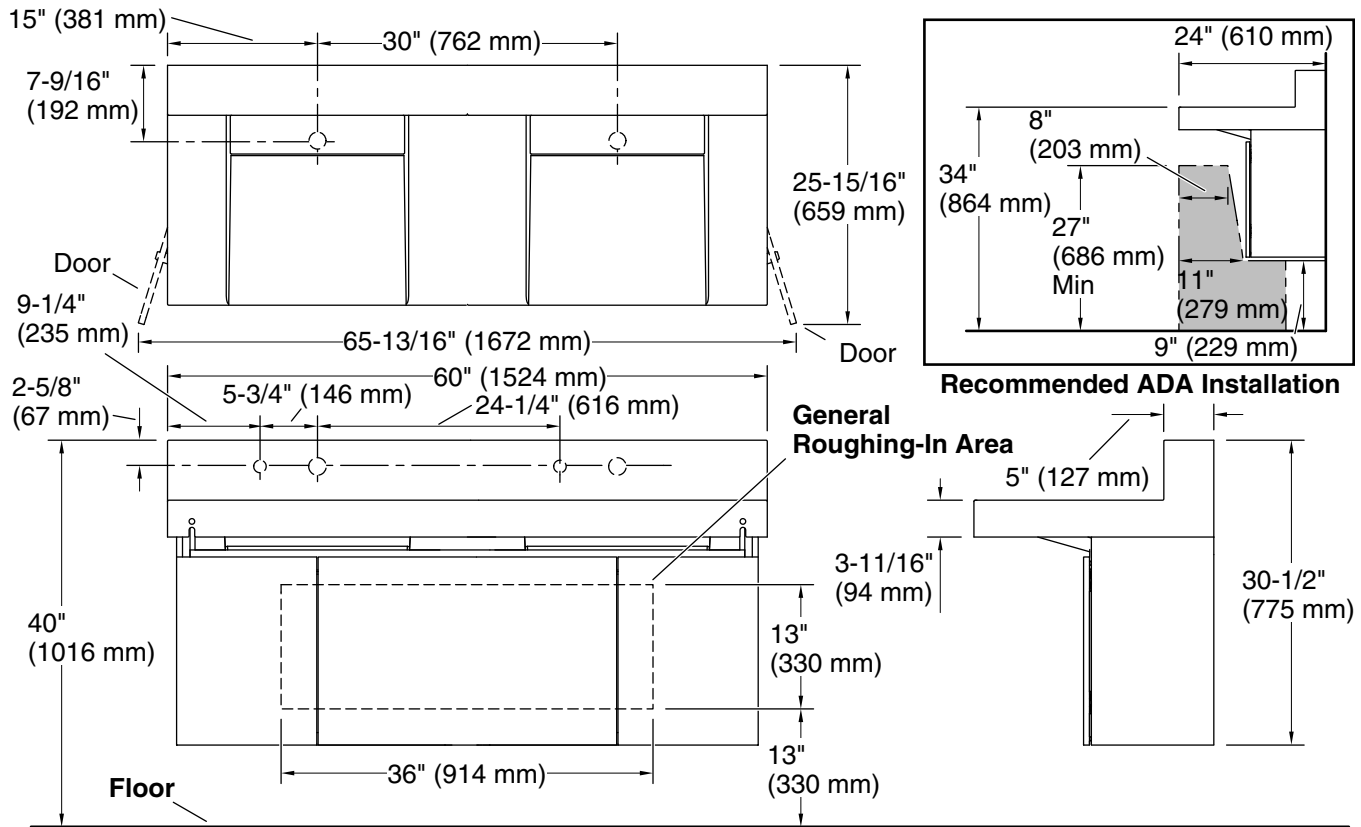

Technical Information

All product dimensions are nominal.

Basin configuration: Equal Bowls
Min. base cabinet width: 24" (610 mm)

With overflow: Yes

Drain hole: 1-3/4" (44 mm)

Notes

Install this product according to the installation instructions.

Select the type of fastener based upon the wall material. 500 lb (227 kg) minimum load bearing fasteners are recommended.

ADA, CSA B651 compliant when installed to the specific requirements of these regulations.