

## Features

- Cross handle
- Push-button diverter
- Completes Purist design solution with KOHLER fixtures and accessories

## Material

- Premium material construction for durability and reliability
- KOHLER finishes resist corrosion and tarnishing

## Required Products/Accessories

K-11748 Series Rite-Temp® Valves

## Optional Products/Accessories

88526 Thin Wall Trim Kit

1016154 Rite-Temp® Deep Rough-In



**ADA**

## Codes/Standards

ASME A112.18.1/CSA B125.1

ADA







ICC/ANSI A117.1

## KOHLER® Faucet Lifetime Limited Warranty

See website for detailed warranty information.

## Available Colors/Finishes

*Color tiles intended for reference only.*

Color	Code	Description
	CP	Polished Chrome
	AF	Vibrant® French Gold
	BN	Vibrant® Brushed Nickel
	BV	Vibrant® Brushed Bronze
	BL	Matte Black
	BGP	Vibrant Brushed Graphite

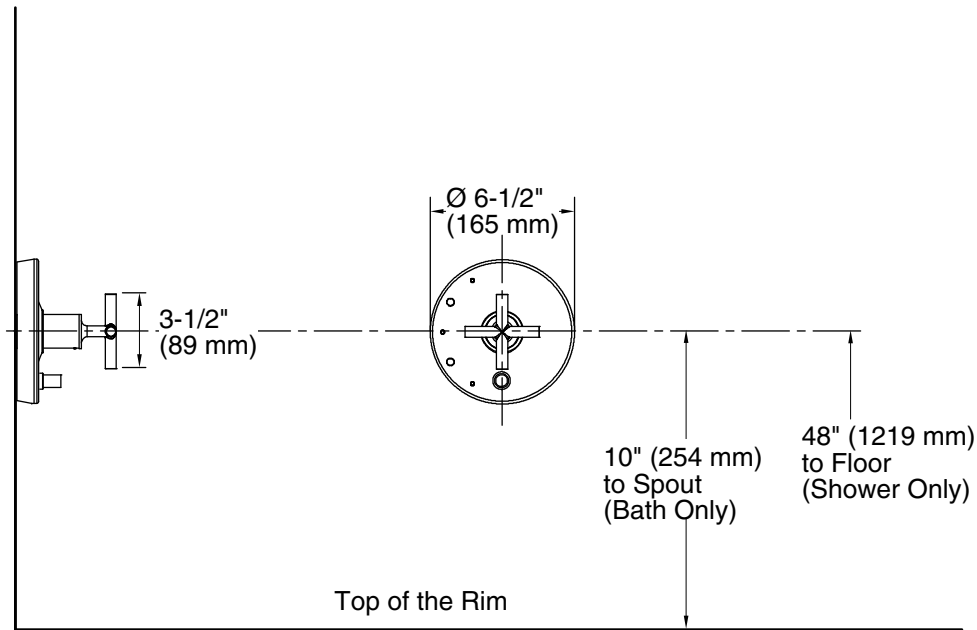

**Technical Information**

All product dimensions are nominal.

**Spout:**

Shower/Rainhead rated max flow: 2.5 gal/min (9.5 l/min)

**Notes**

Install this product according to the installation guide.

NOTICE: Risk of product damage. Long screws, for installing trim, can damage the K-2971-KS valve. Consult the trim installation guide to verify if the thin wall installation kit (88526) is needed.

Avoid cross-flow conditions. Do not install shut-off device on either valve outlet.

Cap shower outlet if deck-mount spout, diverter, or handshower is connected to spout outlet.

Install straight pipe or tube drop of 7" (178 mm) to 18" (457 mm) with single elbow between valve and wall-mount spout.

ADA compliant when installed to the specific requirements of these regulations.