

WYNDHAM COLLECTION

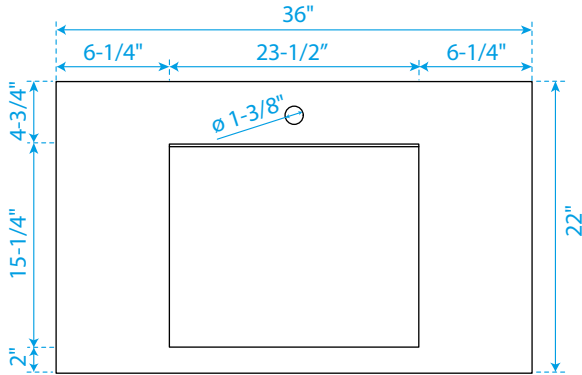

TOP VIEW OF VANITY CABINET

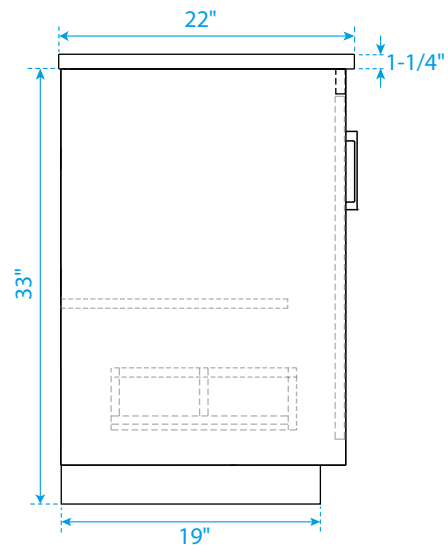
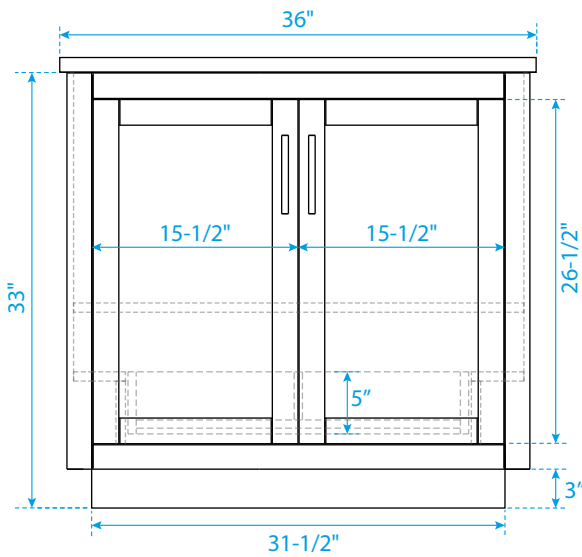
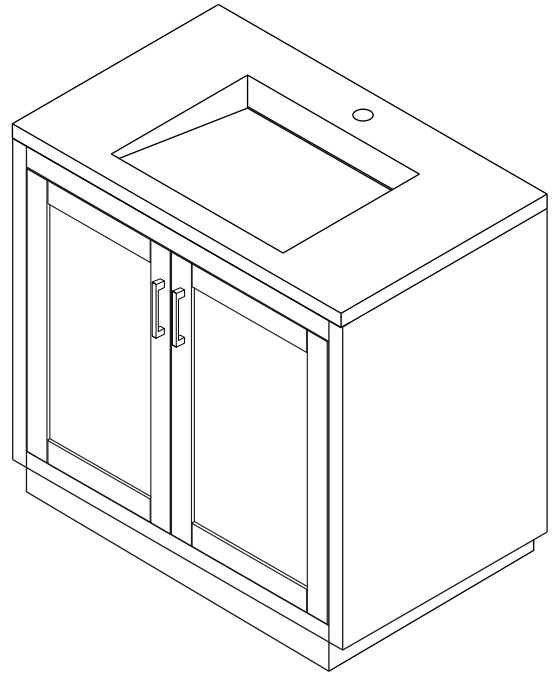
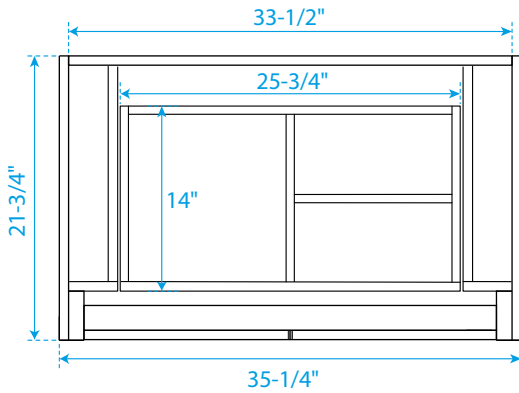

*Note: All measurements are $\pm 1/4"$.

WC-2929-36-SGL
with integrated sinks

WYNDHAM COLLECTION

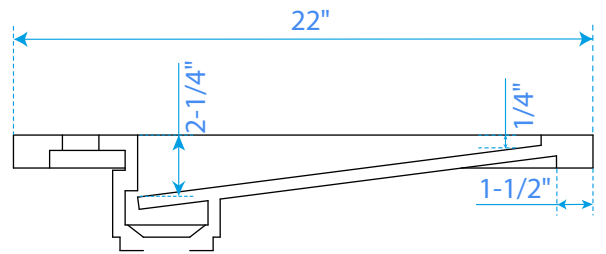
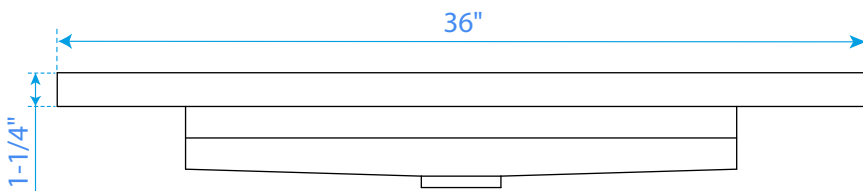
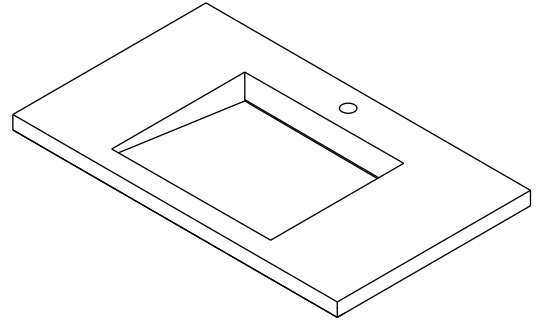
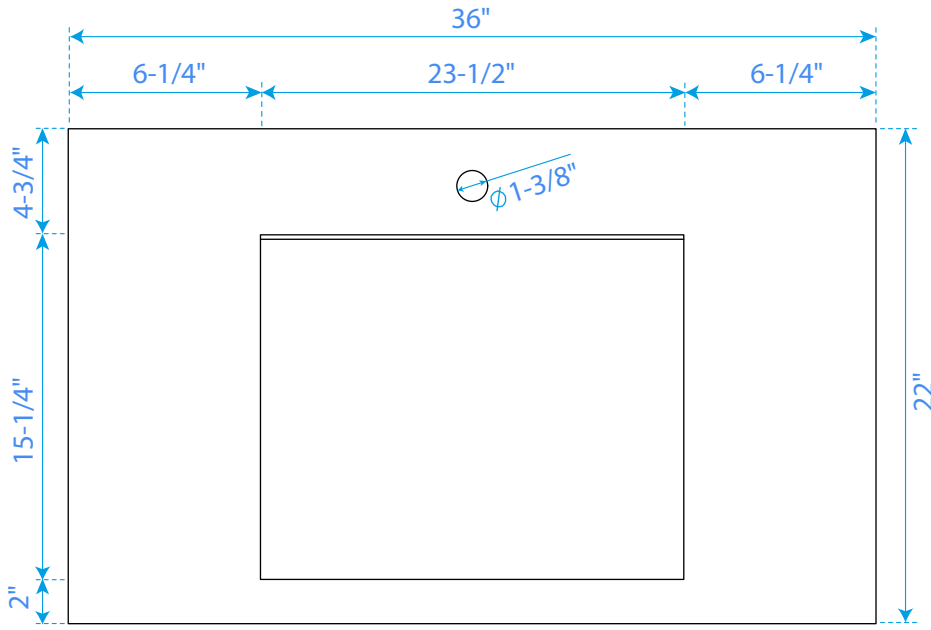

*Note: All measurements are $\pm 1/4"$.

WC-KCI-36-SGL-TOP