

# LACAVA®

*L'Amore per l'Eleganza*

## Owner's Manual Concrete Sinks Installation

### Caution!

Concrete is a fragile material, please unpack your sink and handle it with care. Use protective blankets or sheets for floors and other surfaces that the item will be resting on before it is installed as the bottom can cause scratches. Damage caused during installation is not covered by warranty. Please see our terms and conditions for additional details.



Important: Keep this manual for future technical assistance and/or replacement parts. Please read the instructions within the booklet carefully prior to installation. LACAVA recommends that this fixture be installed by a professional plumber and will not be held responsible for any damage caused by improper installation. It is the responsibility of the homeowner to ensure that this fixture complies with all local plumbing codes. Please see the Terms & Conditions found within this booklet for additional information. For technical assistance please contact 773.637.9600.

Importante: Guarde este manual para futura asistencia técnica y / o piezas de repuesto. Por favor, lea las instrucciones en el folleto cuidadosamente antes de la instalación. LACAVA recomienda que este aparato sea instalado por un técnico y no se hace responsable de los daños causados por una instalación incorrecta. Es la responsabilidad del propietario garantizar que este aparato cumpla con todos los códigos de plomería locales. Por favor, consulte nuestros Términos y Condiciones que se encuentran en este folleto para información adicional. Para obtener asistencia técnica, por favor contacte a: 773.637.9600.

## Table of Contents/Contenido:

Page 2: Installation for Wallmount Sinks with Brackets

Page 3: Installation for Vanity-Top Sinks

Page 4: Installation of Undermount Sinks

Page 5: Installation of Vessel Sinks

Page 6: Unique Nature of Concrete

Page 7: Hairline Crack Repairs, Concrete Chip and Gap Repairs

Page 8: Maintenance of Lacava's Concrete Products

Page 9: Cleaning and Care

Page 10: Warranty

Page 11: Terms and Conditions

# Installation for Wallmount Sinks with Brackets

SURFACE BRACKET

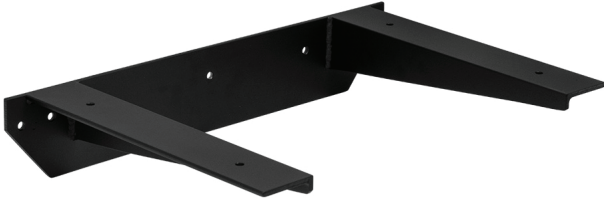

STUD BRACKET

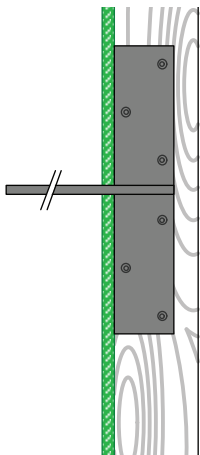

REVERSIBLE STEEL BRACKET  
IN MATTE BLACK  
TO SECURE TO STUDS

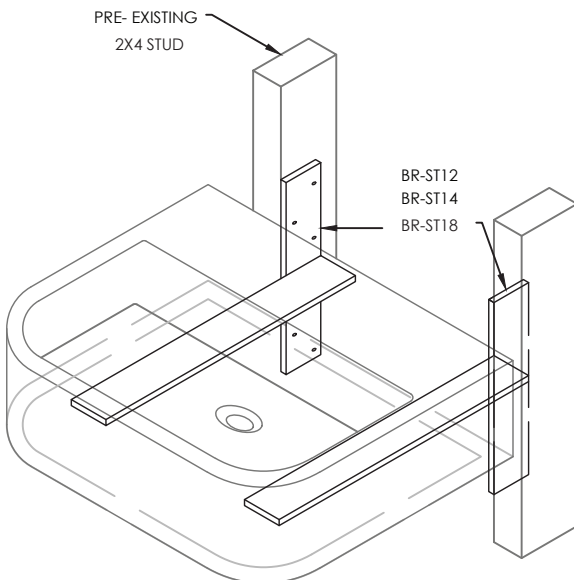

1. Based on the sink's dimensions and mounting height (usually 30"-35" above floor), decide what support will be needed to support the sink.
2. Install proper support for the selected sink, blocking or plywood backing. Once the proper support is in place, install the stud brackets if this is the bracket purchased and finish the wall. See the diagram on the bottom for visual guidance.
3. If surface bracket purchased, trace the bracket and its holes on the wall, drill pilot holes, and attach the bracket to the wall by bolting it to wall studs or installed wall support.
4. Make sure the brackets are level and securely installed.
5. **If the sink does not have holes to bolt it to wall, go to step 7.** If the sink has holes for bolts on the back wall, place the sink on the bracket and trace them on the wall. Make sure the sink surface is level, use rubber bumpers or shims to level the sink perfectly.
6. Remove the sink, drill pilot holes and screw the wood threaded part of the mounting bolts into the pilot holes so that the machine threaded portion is sticking out of the wall. Once the sink is in its place, thread on washers with nuts onto the bolts.
7. Install the faucet and drain assemblies onto the sink based on their instructions.

## CAUTION!

**No metal part should come into contact with concrete - sealant or gasket must always be present in between concrete surface and metal parts. Drains should be installed with plumber's putty and hand-tightened only.**

8. Apply a bead of silicone along the top edges of the brackets and along the wall, and place the sink in its final position.
9. Apply a small bead of silicone around the sink back wall along the top and sides, and clean any excess following the instructions on the label.
10. Connect the P-trap and drain arm to the drain stub-out, and then connect the two water supply lines to the shut off valves. Check for any leaks. Drains should be installed with plumber's putty and hand-tightened only.

# Installation for Vanity-Top Sinks



1. Based on the sink's dimensions and mounting height (usually 30"-35" above floor), decide what support will be needed to support the vanity and sink.
2. Install proper support for the selected vanity, blocking or plywood backing. Once the proper support is in place, finish the wall.
3. Attach the vanity to the wall, bolt it to wall studs or installed wall support.
4. Make sure the vanity is level and securely installed.
5. **If the sink does not have holes to bolt it to wall, go to step 7.** If the sink has holes for bolts on the back wall, place the sink on the vanity and trace them on the wall. Make sure the sink surface is level, use rubber bumpers or shims or sand the edges of the vanity to level the sink perfectly.



6. Remove the sink, drill pilot holes and screw the wood threaded part of the mounting bolts into the pilot holes so that the machine threaded portion is sticking out of the wall.
7. Install the faucet and drain assemblies onto the sink based on their instructions.

## CAUTION!

**No metal part should come into contact with concrete - sealant or gasket must always be present in between concrete surface and metal parts. Drains should be installed with plumber's putty and hand-tightened only.**

8. Apply a bead of silicone along the edge of the vanity's top edges and along the wall, and place the sink in its final position.
9. Apply a small bead of silicone around the sink back wall along the top and sides, and clean any excess following the instructions on the label.
10. Connect the P-trap and drain arm to the drain stub-out, and then connect the two water supply lines to the shut off valves. Check for any leaks. Drains should be installed with plumber's putty and hand-tightened only.
11. If desired, apply a bead of latex caulk around the edge between the sink and the vanity and smooth out.



# Installation for Undermount Sinks



1. Prepare the countertop cutout according to the sink's size.

## **IMPORTANT!**

**The cutout size should be at least 1/4" smaller on all sides than the inside dimensions of the sink.**

2. Apply a small bead of silicone around the top edge of the washbasin, making sure to follow the directions on the label.

3. Place the countertop upside down and then position the washbasin over the cutout in the top.



4. If mounting clips or brackets provided, place each of the mounting clips around the edge of the sink. Then tighten each clip into place using the provided screws and wipe up any excess sealant.

## **IMPORTANT!**

**If no brackets or clips provided, use sealant proper for the countertop material and let the sealant set completely for proper bonding, following the instructions on the bottle.**



5. Turn the countertop right side up, attach to the vanity, and then hook up the faucet, drain and supply lines.

## **CAUTION!**

**No metal part should come into contact with concrete - sealant or gasket must always be present in between concrete surface and metal parts. Drains should be installed with plumber's putty and hand-tightened only.**

# Installation for Vessel Sinks

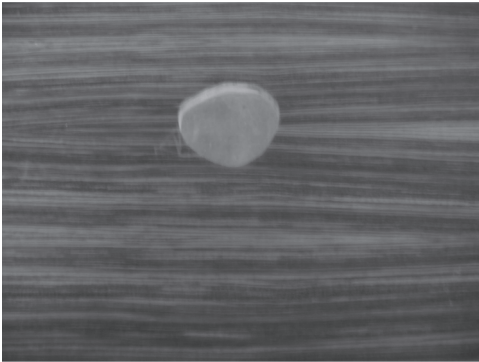

1. Refer to the sink specs for proper cutout size. For most above-counter and vessel sinks a standard cutout of 4"-6" will work. The cutout has to be just large enough so that the drain assembly can be tightened directly onto the porcelain.

## **IMPORTANT!**

**The drain assembly does not attach the sink to the countertop.**

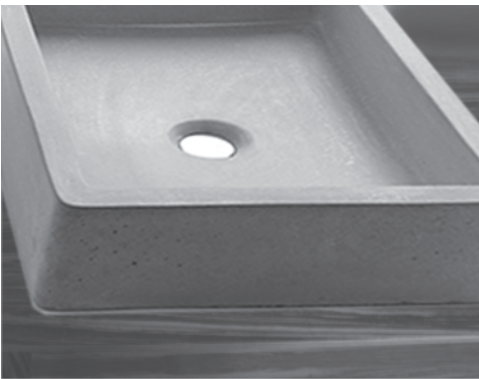

2. Temporarily position the sink over the cutout and make sure that it is aligned properly, leaving clearance for supply lines, drain, and faucet assemblies.

3. Make marks with a pencil on the countertop and sink as a guide for installation.

4. Install the drain and faucet assemblies onto the sink as applicable.



## **CAUTION!**

**No metal part should come into contact with concrete - sealant or gasket must always be present in between concrete surface and metal parts.**

**Drains should be installed with plumber's putty and hand-tightened only.**

5. Turn the sink upside down and apply a small bead of silicone around the bottom edge of the sink, following the instructions on the label.

6. Place the sink onto the desired location, aligning it with the guide marks, and press down to ensure a tight seal. Let the sealant set, as stated in the label's instructions, and then connect the supply lines and drain pipes. Drains should be installed with plumber's putty and hand-tightened only.



## Unique Nature of Concrete



Our handcrafted concrete sinks celebrate their natural, unique character, featuring variations in color, texture, pores, lines, seams, and small surface holes caused by trapped air during casting - all of which are inherent and do not compromise durability. Made from traditional mixes of gravel, crushed stone, sand, and cement, each piece is individually crafted, resulting in one-of-a-kind products with organic, stone-like qualities and a rich patina, emphasizing the beauty of natural imperfections. These features, including visible aggregates, subtle cracks, and color and texture variations due to the mixing process and curing, are natural to concrete, highlighting its authentic and artisanal nature. Please consider your comfort level with these distinctive characteristics before placing an order, as each sink will be unique in nature and slightly different from the photography shown on our website.

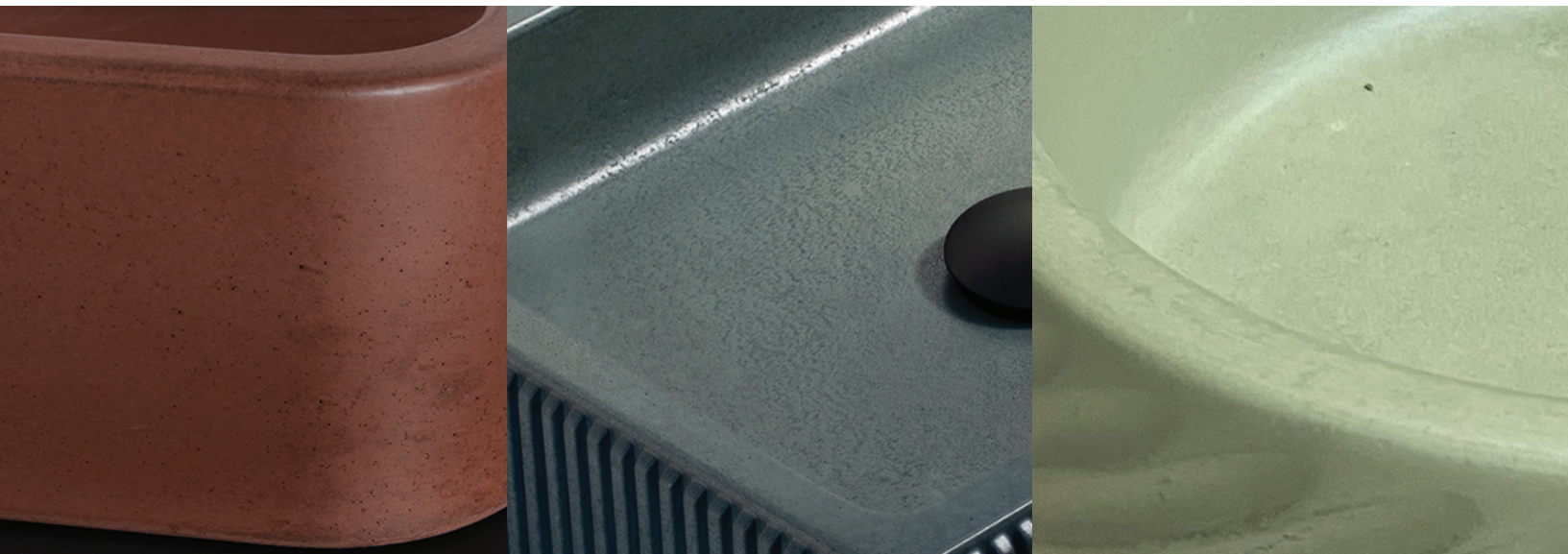

# Hairline Crack Repairs

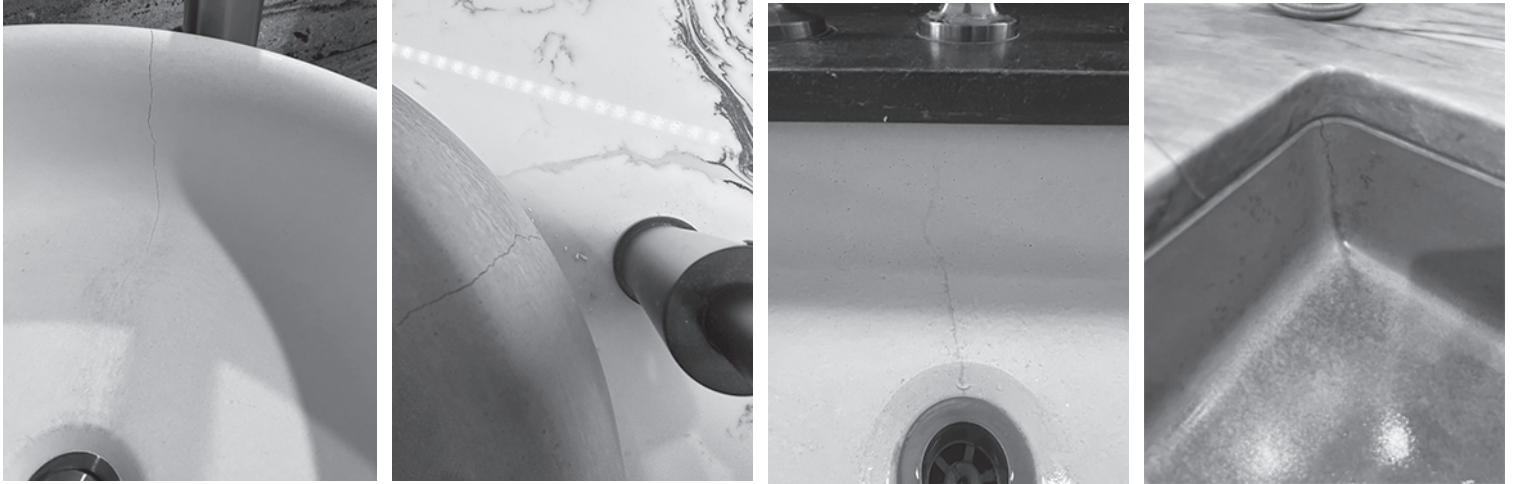

Small, hairline cracks in concrete are very common and are likely to develop over time due to the chemical reactions in the lifelong curing process of the material. Small cracks do not impact the structural soundness or performance of the concrete product. This physical characteristic of the materials has been addressed with a multitude of concrete crack repair compounds available on the market at general home improvement stores as well as plumbing stores. We recommend products, like Quikrete, made for commercial grade repairs. The crack repair filler/sealer needs to be worked well into the hairline crack from all angles for best results.

Each concrete product is slightly unique and might develop different crack patterns. These markings add individual style and personal character to the product, enhancing texture and color variations. Being a mixture of natural materials that undergo lifelong chemical changes, concrete will change over time in terms of color, patina, and crack patterns.

## Concrete Chip and Gap Repairs

Concrete surface may chip when exposed to a heavy impact or sharp objects. Those can be successfully repaired. Standard and common procedures for repairing chips include the following steps (please make sure to follow the filler putty instructions on the label, they supersede these general guidelines below):

1. Using painter's tape, tape off surrounding surfaces that should not be exposed to the processes that will follow. Make sure the tape does not cover the edges of the chip that needs to be repaired.
2. On a cardboard surface, mix the filler putty as recommended by the manufacturer.
3. Fill the chipped surface with the putty mix completely, make sure to work the putty well from all angles into all nooks and crannies so it sticks well across the whole void surface.
4. Make sure to overfill the chipped area, and then remove the excess material with an even and flat object, like a razor blade or putty knife.
5. Let it fully cure. If gaps develop in the curing process or the chipped surface is not even with rest of the surface, they should be filled with another application of the putty mix, as in steps 1-4.
6. After the filler putty fully cures, it should be sanded or shaved to be perfectly even with the surrounding area.
7. The concrete surface should be re-sealed to ensure even finish and best blending between the repaired chip and the surrounding area.

# Maintenance of Lacava's Concrete Products

Our concrete products, including sinks, vanity tops, and shower bases, are made for use in wet areas, thus, they are treated with several different sealants and coats to help protect them from moisture and humidity. However, special cleaning and care instructions should be followed to ensure that the finish continues to look new and clean for years to come.

Regular cleaning should be done using warm water and mild detergent solution, e. g. dishwashing soap. Any other cleaning agents used should be labeled as safe for sealed concrete products and should be tested in an inconspicuous area first to make sure they do not discolor or damage the surface. After washing the product surface, rinse it with clean water and dry with soft cloth. NEVER use coarse abrasive materials which will scratch and discolor the surface and always avoid using products that contain ammonia, bleach, and acid. Damage due to improper cleaning and care will not be accepted as a valid reason for a return or exchange and may void the warranty.

Concrete products may need to be re-sealed every few years depending on the traffic and use. This is a normal and expected maintenance process.

We recommend invisible water-based concrete and masonry sealers that penetrate the surface without leaving a heavy surface residue. They may require multiple coats. It is important to follow the manufacturer's detailed step-by-step instructions for successful and satisfactory results. We recommend spot testing the sealing product in a inconspicuous area to make sure it will not change the color or leave undesirable residue on the surface of the concrete product.

Standard and common procedures of the re-sealing process include the following steps (please make sure to follow the sealer's instructions on the label, they supersede these general guidelines below):

1. Using painter's tape, tape off surrounding surfaces that should not be exposed to the processes that will follow.
2. To ensure the best adhesion of the sealer to the concrete surface, uniformly sand the entire surface with very fine sand paper, e.g. 220-grit. Any patterns left in the surface will prevail after application of the sealer.
3. Clean the surface from dirt and dust with water and a rag. This may require several repetitions until the surface is completely clean. Let it dry completely.
4. After preparing the sealer in accordance with the manufacturer's instructions, apply it evenly with a brush or roller on the concrete surface.
5. Starting on one side, pour the sealer onto the concrete and roll it over the surface in all directions evenly, add more sealers as needed on the already coated surface to continue spreading it into the uncoated surface.
6. Feather in any access sealer to make sure the surface is evenly coated and there are no visible roller or brush stroke lines or standing sealer puddles. Do not overapply the sealer.
7. If necessary, apply additional coats of the sealer based on the sealing product label.
8. Once the sealer coatings are finished, clean all surrounding areas and equipment as recommended by the sealing product labels.

## Cleaning and Care

For best results, please care for this product in accordance with the following instructions:

- Only use warm water and a mild detergent (i.e. dishwashing soap) for cleaning.
- If another cleaner is used, check the label to make sure that it is safe for use on the material being cleaned and always test in an inconspicuous area first.
- Make sure to wipe any excess cleaners off with a damp sponge or cloth and then rinse with water.
- Dry the surface with a soft cloth until dry after each use.
- Never use abrasive materials or cleaners that contain ammonia, bleach or acid, since they can cause damage to the finished surface.

*We would like to thank you for your purchase and are confident that you will be able to enjoy our products for many years to come!*

## Cuidado y Limpieza

Para mejores resultados, por favor cuide des este producto de acuerdo con las siguientes instrucciones:

- Sólo utilice agua tibia y un detergente suave (es decir, el jabón para lavar la vajilla) para la limpieza.
- Si se utiliza otro limpiador, revise la etiqueta para asegurarse de que es seguro para el uso del material para su limpieza y siempre prueba en un área discreta primero.
- Asegúrese de limpiar cualquier exceso de producto de limpieza con una esponja o un trapo húmedo y luego enjuague con agua.
- Seque la superficie con un paño suave hasta que se seque después de cada uso.
- Nunca use materiales abrasivos o productos de limpieza que contienen amoníaco, lejía o ácido, ya que pueden causar daños a la superficie acabada.

*¡Nos gustaría darle las gracias por su compra y estamos seguros que usted podrá disfrutar de nuestros productos por muchos años!*

## Warranty

LACAVA warrants its products to be free from any defects in materials or workmanship, during normal residential or commercial use including all hinges, drawer slides, cartridges, finishes, and general workmanship of the item. LACAVA warranties do not cover normal wear and tear, damages due to negligence, improper installation, alterations, improper repairs, improper use, improper maintenance, or damages due to uses of the product other than its intended and normal use. All warranties last for a period of one year from the date of purchase. If a defect is found under normal use, while under warranty, LACAVA will repair or replace the product (whichever cost is smaller to LACAVA) at its own expense (excluding shipping and installation charges). Under no circumstances is LACAVA responsible for installation/service fees or any dollar amount beyond the cost of the item. In addition, all LACAVA products are to be installed by experienced professionals properly licensed and bonded; otherwise, any LACAVA warranty and liability is to be considered waived. All warranties are non-transferable and proof of purchase is required for any warranty claim.

In accordance with the laws of limitation and exclusion state by state, and therefore provided the duly exceptions, LACAVA will not be held liable, in any event, for any special, indirect, incidental or consequential damages or losses (including but not limited to damages for loss of business, loss of profits, etc.) for breach of contract, tort (including negligence), product liability or otherwise, even if it has been advised of the possibility of such damages. LACAVA's liability on any claim (including negligence) will not in any case exceed the contract price paid by the original purchaser for the product claimed defective or unsuitable. It is the responsibility of the homeowner to ensure that all installed fixtures comply with all local plumbing codes.

## Garantía

LACAVA garantiza que sus productos están libres de defectos en materiales o mano de obra, durante el uso residencial o comercial normal, incluyendo todas las bisagras, cajón portaobjetos, cartuchos, acabados, y en calidad general. LACAVA no cubren el desgaste normal, daños debidos a negligencia, instalación incorrecta, alteraciones, reparaciones incorrectas, uso incorrecto, mantenimiento inadecuado, o daños debido a los usos del producto que no sean su uso previsto y normal. Todas las garantías son por un año desde la fecha de compra. Si un defecto se encuentra en condiciones de uso normal, mientras que esta bajo garantía, LACAVA reparará o reemplazará el producto (lo que sea el menor costo para LACAVA) sin cobro (excluyendo los gastos de envío y la instalación). Bajo ninguna circunstancia LACAVA se hace responsable de la instalación y tarifas de servicio o cualquier cantidad de dinero más allá del costo del elemento. Además, todos los productos de LACAVA deben ser instalados por profesionales con experiencia, con la licencia y cobertura de seguro adecuada, de lo contrario, cualquier garantía ofrecida por LACAVA será anulada. Las garantías de LACAVA no son transferibles. Se requiere prueba de compra para cualquier reclamación de garantía.

En conformidad con las leyes de la limitación y exclusión de estado a estado, y con las excepciones aquí debidamente presentadas, LACAVA no será responsable, en cualquier caso, por ningún daño especial, indirecto, incidental o consecuencial o pérdidas (incluyendo pero no limitadas a daños por pérdida de negocio, pérdida de beneficios, etc) por incumplimiento de contrato, agravio (incluyendo negligencia), responsabilidad por productos defectuosos o de otro modo, incluso si se ha advertido de la posibilidad de tales daños. La Responsabilidad de LACAVA en caso de reclamaciones (incluyendo negligencia) no superarán en ningún caso el precio del contrato pagado por el comprador original del producto reclamado defectuoso o no apto. Es la responsabilidad del propietario garantizar que todos los accesorios instalados cumplan con todos los códigos de plomería locales.

# Terms and Conditions

## UNIQUENESS:

Many LACAVA products are made of natural stone, woods, or metals. Because of the natural variations, and/or handmade nature of the products, slight differences are expected and are not deemed manufacturing defects.

## SHIPPING POLICIES:

Once the merchandise is released to and accepted by the carrier, LACAVA's responsibility ends. LACAVA LLC is not responsible for damages occurring in transit. After the merchandise is delivered and the shipping document is signed, it becomes the property of the purchaser. We constantly improve the packaging as new technologies become available, but damages in transit may still occur. Therefore, we recommend that all packages be inspected by the purchaser in the carrier's presence upon delivery. In case of damages, either visible or concealed, the purchaser is responsible for filing any damage claim against the carrier. In this regretful circumstance, we suggest utter diligence to have the carrier's agent explain the steps to submit a valid claim against the carrier, as each carrier has different claim policies. Please document everything in writing, preferably on the shipping documents and have also the carrier's agent sign along. If you wish that Lacava assists you in the claim process, please fax or email us copies of the shipping and claim documents at your earliest convenience. In the case of missing items, which could occur due to our mistake or a theft during transit, please follow same procedures as for shipping damages above, with the only difference that the claim concerns something completely missing, rather than damaged. Please take note of any visible tampering with the packaging in the presence of the carrier's agent before accepting the delivery with your signature. In case of missing items, you must also inform LACAVA and send us all related documents within 24 hours from the delivery date. We will open an internal investigation and check the inventory count to determine whether it was our error. If we verify it was our mistake, we will promptly ship the missing item(s) to the purchaser by standard ground at our cost.

## RETURN POLICIES:

If the product is not satisfactory for any reason different from defects, it can be returned to LACAVA LLC up to 30 days from the shipping date after obtaining a Return Goods Authorization (RGA) valid for 60 days. If the product is not returned to LACAVA within that timeframe, the RGA will be voided and no further RGAs will be issued for the product. The merchandise must be in salable condition, in its original packaging, and packed safely with the RGA number clearly marked on the outside packaging. To obtain an RGA number, please fax or email the request with a description of the reason for return. The merchandise must be in its original packaging and packed safely in accordance with the carrier's packing requirements, with the RGA number clearly marked on the outside packaging. LACAVA reserves the right not to issue any credit, if an approved RGA number has not been obtained. A restocking fee of 25 percent and applicable shipping charges to the customer and back will be deducted from the credit amount. Credit (excluding shipping and handling charges) will be given only for returns of intact products up to 30 days from the shipping date. After 30 days from the shipping date, no returns will be accepted. All returned merchandise is at the purchaser's risk and cost. Special order and custom made items are not returnable. Products must be inspected prior to installation and installation of the product means its acceptance. Product, once installed, cannot be returned. Damages occurring in installation are not considered defects and are not subject to return or refund. LACAVA will replace any defective item for free only after the non-conforming product is safely returned to LACAVA's warehouse safely in accordance with the carrier's packing requirements, and in its original packaging, within 30 days from the shipping date. If the product is not found to be defective and is damaged in any way, there may be a charge for any replacement. In any case, LACAVA does not cover installation costs.

# Términos y Condiciones

## SINGULARIDAD:

Muchos productos están hechos de piedra natural, maderas o metales. Debido a las variaciones naturales, y / o la naturaleza de los productos artesanales, pequeñas diferencias se pueden esperar y no se consideran defectos de fabricación.

## POLÍTICAS DE ENVÍO:

Una vez que la mercancía es entregada y aceptada por la compañía de transporte, la responsabilidad de LACAVA termina. LACAVA LLC no es responsable por daños ocurridos en tránsito. Después que la mercancía se entrega y el cliente firma el documento de transporte, la mercancía se convierte en la propiedad del comprador. Con el avance de tecnología estamos constantemente mejorando nuestros modos de empaque. Pero los daños en tránsito aun pueden ocurrir. Por lo tanto, se recomienda que todos los paquetes sean inspeccionados por el comprador en presencia de la compañía ala hora de entrega. En el caso de daños, ya sea visible o encubierto, el comprador es responsable de presentar cualquier reclamo por daños contra el transportista. En esta circunstancia lamentable, le sugerimos que ser muy cauteloso y pedir a el agente de la compañía que le explique los pasos para presentar una demanda legal contra la compañía (ya que cada compañía tiene políticas de demanda diferentes). Documente todo por escrito, de preferencia en los documentos de embarque, también pida a el agente/chofer que firme a lo largo. Si usted desea que nosotros, le ayudemos en el proceso de reclamo, envíenos por fax copias de los documentos de envío y reclamo a la más brevedad posible. En el caso de que falte mercancía a su orden, ya que no sabemos si se debe nuestro error o de un robo durante el transporte, por favor, siga el mismo proceso que el anterior. Con la única diferencia de que el reclamo será por algo completamente desaparecido, y no por daño. Por favor note, en la presencia del agente/chofer de la compañía, cualquier alteración visible en el empaque. En el caso que falten artículos, también hay que informar a LACAVA y enviar todos los documentos relacionados con un plazo de 24 horas a partir de la fecha de entrega. Vamos a abrir una investigación interna y verificar el recuento de inventario para determinar si fue un error de nuestra parte. Si nos damos cuenta que fue nuestro error, rápidamente se le enviara el artículo que falta al comprador por UPS (tierra) sin costo extra.

## PÓLIZAS DE DEVOLUCIÓN:

LACAVA reemplazará cualquier producto defectuoso debido a defectos de fabricación sólo después de la no conformidad del producto se devuelve al almacén LACAVA en condición vendible plazo de 30 (treinta) días a partir de la fecha de envío. En cualquier caso, LACAVA no cubre los costes de instalación. Si el producto no es satisfactorio, por cualquier motivo diferente de los defectos, que pueden ser devueltos a LACAVA LLC hasta 30 (treinta) días a partir de la fecha de envío después de obtener una Autorización de Devolución de Bienes (RGA), válida por 60 días. Si el producto no se devuelve a LACAVA dentro de ese plazo, la RGA se anularán y no se RGA se emitirán nuevos para el producto. La mercancía debe estar en su embalaje original y embalado de forma segura. Una tasa de reposición de 25 por ciento y los gastos de envío aplicables a los clientes y la espalda se deducirá de la cantidad del crédito. De crédito (excluyendo gastos de envío) se dará sólo para las devoluciones de productos intactos hasta 30 días a partir de la fecha de envío. Después de 30 días a partir de la fecha de envío, no se aceptarán devoluciones. Toda la mercancía devuelta es a riesgo del comprador y el costo. Especial orden y artículos personalizados no son retornables. Los productos deben ser inspeccionados antes de la instalación y la instalación del producto, su aceptación. Producto, una vez instalado, no pueden ser devueltos. Los daños se producen en la instalación no se consideran defectos y no están sujetos a devolución o reembolso.