

Petra 7 CS

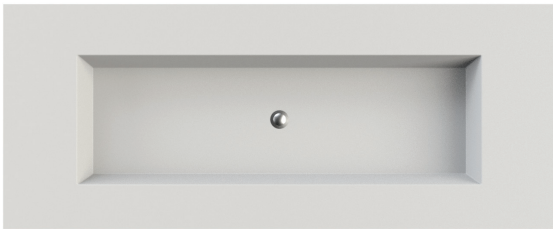

Visit <https://configurator.mtibaths.com> to create your custom counter-sink.

MODEL 807
Bowl: 39.5" x 12.5"
WALL MOUNT or VANITY MOUNT
SculptureStone®

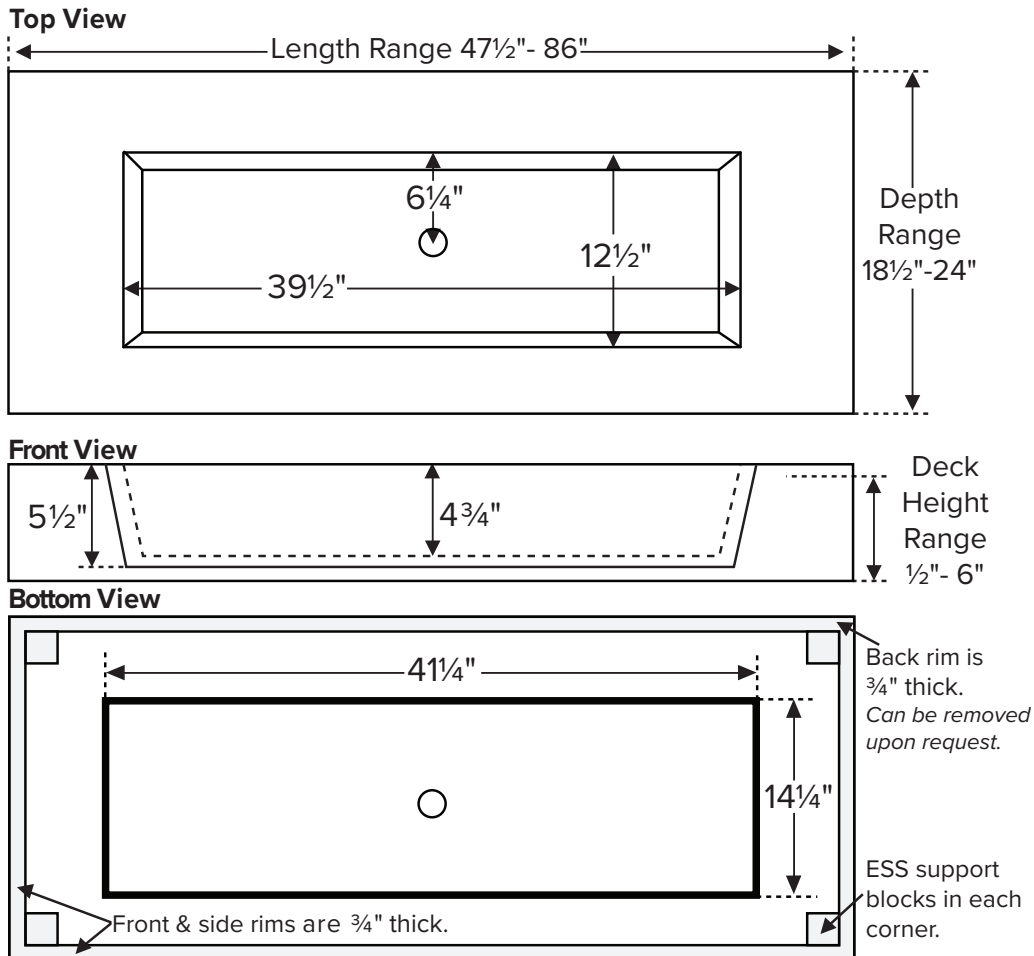

ORDERING AND INSTALLATION

- Due to the handcrafted nature of this product, please allow for a tolerance of ±¼" for overall dimensions and ±½" for bowl placement.
- Corner support blocks are necessary only when deck height is over 1".
- All sides planned to install against a wall or other structure will be unfinished. Sides indicated as visible on order will be finished.
- Carefully review inside vanity specifications to ensure that there is proper clearance to accommodate the bowl, drain and optional integrated overflow, if applicable.
- Please take into consideration the thickness of material under the countertop when positioning sink bowl, using a deck-mounted faucet or adding an integrated overflow.
- Outside of overflow housing protrudes approx. ¾" from the bowl and may impact bowl placement.

• Check for accessories before discarding packaging.
 • All product measurements are ±1/2".
 • Specifications and configurations are subject to change without notice.
 • Measurements herein supersede all others published prior to publication date below.

MTCS-807

©2025 by MTI Baths, Inc. Modification Rights Reserved

See Product Manual for details.
 MTI's Customer Service
 Monday-Friday 8am-6pm EST
 800-783-8827 or service@mtibaths.com



Rev. 12 20 2024