

Incline 2

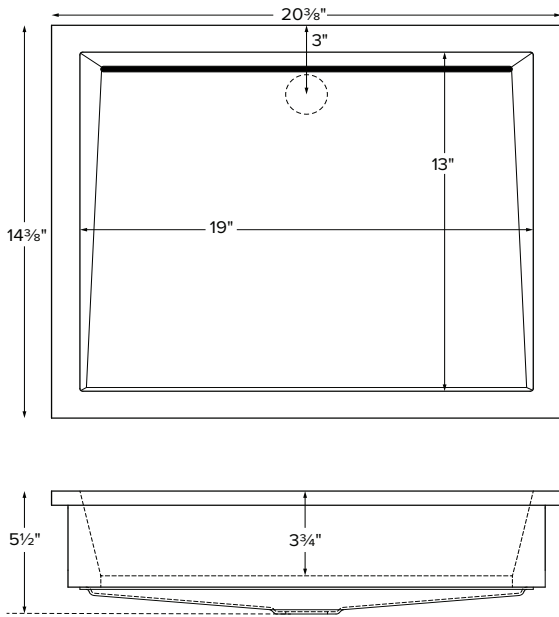

The Incline is an undermount only sink, with a slotted drain at the rear of the bowl.

MODEL 770
20.375" x 14.375" x 5.5" Bowl: 19" x 13"
UNDERMOUNT ONLY
SculptureStone®
25 lbs / 11 kg



Due to its handcrafted nature, always measure sink on-site to ensure cut-out accuracy when undermounting.

Finish	Part #	MSRP
soft matte white	MTCS770	\$1,510
hand-polished gloss white	MTCS770GL	\$2,285

Options Must be ordered at time of purchase

Biscuit Color Upgrade (SSBISNK) +\$130
Additional material colors available for projects only. Please call MTI.

Quick Ship (QSPRI3) \$280 reduces lead time
Please call for availability.

Accessories Must be ordered at time of purchase

Drain Kit included with sink with ABS drain trough and chrome finish brass tailpiece.

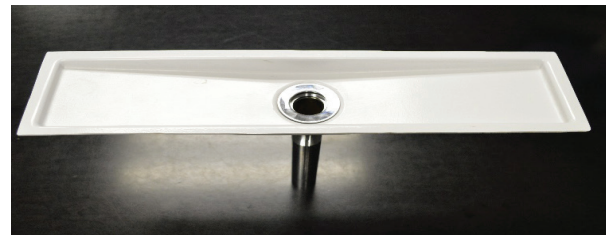

Drain assembly included with sink.

ORDERING AND INSTALLATION

- Slotted drain with ABS trough and chrome finish brass tailpiece
- No overflow available. Check local codes.
- undermount only. Measure on site to achieve the proper cut-out size.
- Lip detail will accommodate commonly used undermount hardware. undermount hardware is not included.
- One-piece construction using Engineered SculptureStone® (ESS) material.
- Non-porous, stain-, mold- and mildew-resistant SculptureStone®
- Material is approximately 70% organic
- Five-Year Limited Residential Warranty



Also available, Incline Counter-Sink 2, featuring custom-size countertop with integrated bowl. Offered in single and double bowl configurations..

• Before discarding packaging, check for accessories that may be inside.
• All product measurements are ±1/2".
• Specifications and configurations are subject to change without notice.
• Measurements herein supersede all others published prior to publication date below.